

Data Sheet



Article number: 02150000066

Description: Sealing Clamp S 66 W1

Measures

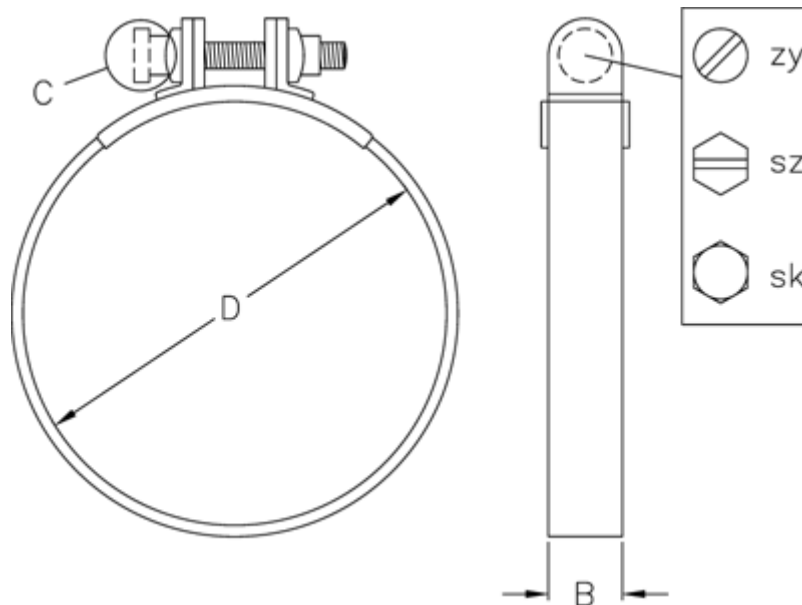

C (screw type) = SZ

Diameter D = 66

Width B = 20